

THIS DRAWING IS UNPUBLISHED. RELEASED FOR PUBLICATION
 © COPYRIGHT - By - ALL RIGHTS RESERVED.

LOC	DIST	REVISIONS					
AF	50	P	LTR	DESCRIPTION	DATE	DWN	APVD
		N		REVISED PER ECR-13-001204	28MAY13	KH	PD

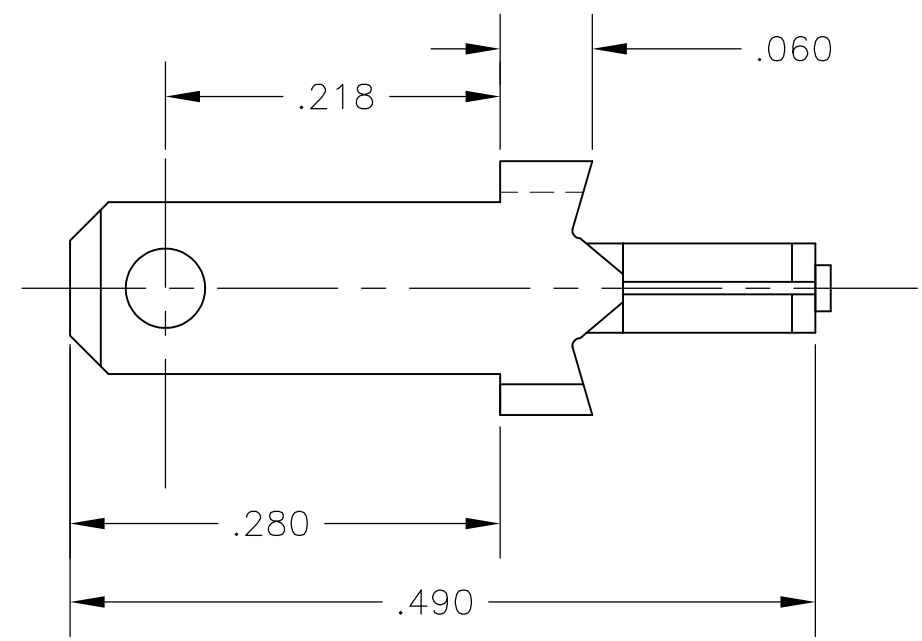

- 1 SUPPLIED IN LOOSE PIECE
- 2 PARTS TO MEET SOLDERABILITY SPEC 109-11-2 (MILDLY ACTIVATED ROSIN).
- 3 .000150 MIN TIN PLATE OVER .000100 MIN COPPER.
- 4 PRINTED CIRCUIT BOARD IS TO BE .032 TO .093 THK WITH A .055-.060 DIA HOLE.

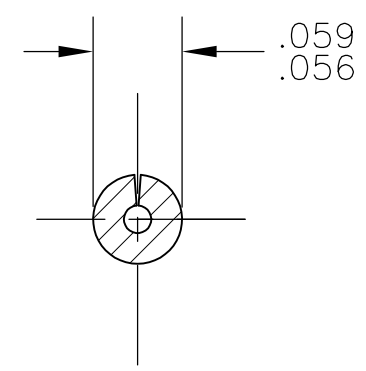
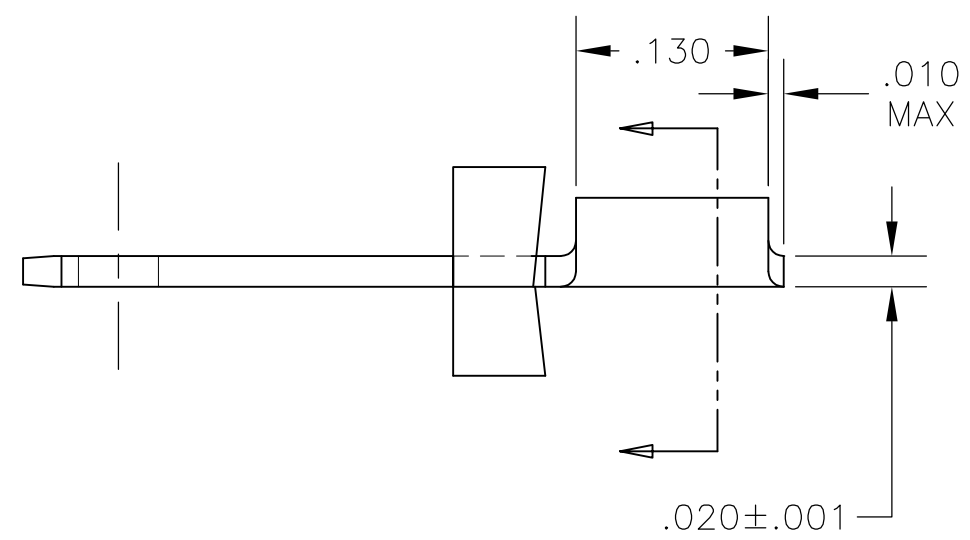
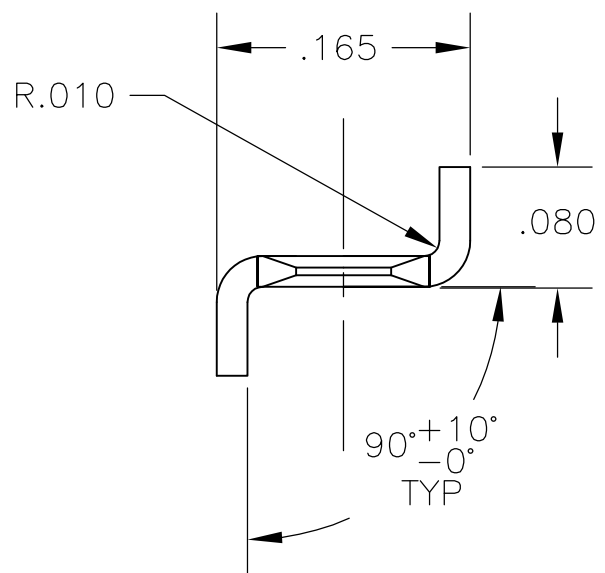

	$\triangle 3$	61134-3
OBSOLETE	GOLD	61134-2
OBSOLETE	PRE-TIN	61134-1
	FINISH	PART NO.

THIS DRAWING IS A CONTROLLED DOCUMENT.		DWN	JR RUTH	15MAR01	STE TE Connectivity											
DIMENSIONS: INCHES		CHK	MS FEHER	16MAR01												
TOLERANCES UNLESS OTHERWISE SPECIFIED:		APVD	N DEIBERT	16MAR01												
<table border="1"> <tr><td>0 PLC</td><td>± -</td></tr> <tr><td>1 PLC</td><td>± -</td></tr> <tr><td>2 PLC</td><td>± -</td></tr> <tr><td>3 PLC</td><td>± .015</td></tr> <tr><td>4 PLC</td><td>± -</td></tr> <tr><td>ANGLES</td><td>± -</td></tr> </table>		0 PLC	± -	1 PLC		± -	2 PLC	± -	3 PLC	± .015	4 PLC	± -	ANGLES	± -	NAME	
0 PLC	± -															
1 PLC	± -															
2 PLC	± -															
3 PLC	± .015															
4 PLC	± -															
ANGLES	± -															
MATERIAL	BRASS	FINISH	SEE TABLE	PRODUCT SPEC	---											
		APPLICATION SPEC	---	SIZE	A3											
		WEIGHT	-	CAGE CODE	00779											
		CUSTOMER DRAWING		DRAWING NO	C-61134											
				RESTRICTED TO	---											
				SCALE	8:1											
				SHEET	1 OF 1											
				REV	N											